

# LUCAS GIRLING

# EQUIPMENT AND SERVICE PARTS

**BRITCYCLE**  
www.britcycle.com.au

CE824/67

# B.S.A.

Motor Cycles

# 1967



*This publication incorporates  
NVS 2336 and 2339 which  
should be destroyed.*

[www.britcycle.com.au](http://www.britcycle.com.au)



**EQUIPMENT SPECIFICATIONS AND PAGE INDEX**

UNIT	See Page	650 c.c. A65 'Hornet'		500 c.c. A50 'Royal Star' 650 c.c. A65 'Thunderbolt' 650 c.c. A65 'Lightning' 650 c.c. A65 'Spitfire' Mk. III		250 c.c. 'Barracuda' 350 c.c. B44 'Roadster'		440 c.c. B44 'Victor-Enduro'	
		Model	Part No.	Model	Part No.	Model	Part No.	Model	Part No.
<b>ALTERNATOR serviced by:—</b>	3	RM19	—	RM19	—	RM19	—	RM19	—
Rotor ... ..	3	—	54213901	—	54213901	—	54213901	—	54213901
Stator ... ..	3	—	47197A	—	47162A	—	47162A	—	47197A
<b>AMMETER</b> ... ..	3	—	—	2AR	†36296A	2AR	†36296A	—	—
<b>BATTERY</b> ... ..	—	—	—	PUZ5A	54027029	PUZ5A	54027029	—	—
<b>CABLE HARNESS</b> ... ..	—	—	54934952	—	54950625	—	54952732	—	54933943
<b>COIL, IGNITION</b> ... ..	3	3ET (L.H.)	45150A	MA12	†45110D	MA12	†45110D	3ET	45149A
<b>CONDENSER</b> ... ..	3	—	†54441582	—	—	—	—	—	—
<b>CONTACT BREAKER</b> ... ..	3	4CA	*47612E (425379 and 54416150)	4CA	*47628A (425379 and 54419167)	4CA	47621D (54415296 and 54416405)	4CA	*47624A (54415296 and 54417989)
<b>DIODE, ZENER</b> ... ..	3	—	—	ZD715	49345A	ZD715	49345A	—	—
<b>FUSED EARTH LEAD</b> ... ..	3	—	—	—	54938986	—	—	—	—
<b>HORN</b> ... ..	3	—	—	6H	*70197A (70183)	6H	*70197A (70183)	—	—
<b>LAMPS</b>									
Head									
Home and Export ... ..	4	—	—	SS700P	59658A/B	SS700P	59658A/B	MCH66	58395L
Export Europe ... ..	4	—	—	SS700P	59660A/B	SS700P	59660A/B	—	—
Export France ... ..	4	—	—	SS700P	59659B/D	SS700P	59659B/D	—	—
Stop tail, number plate illumination and reflex	5	—	—	679	53973D	679	53973D	679	53972D
<b>RECTIFIER</b> ... ..	3	—	—	2D5506	49072A	2D5506	49072A	—	—
<b>SWITCHES</b>									
Dipper ... ..	5	—	—	—	—	—	—	P59	†31620F
Engine cut-out ... ..	5	SS5	*31071D (31107)	—	—	—	—	—	—
Ignition ... ..	5	—	—	S45	31899B	S45	31899B	—	—
Lighting ... ..	5	—	—	88SA	†34289A	88SA	†34289A	PS6	†31356B
Knob ... ..	5	—	—	—	†54330934	—	†54330934	—	—
Socket with cables ... ..	5	—	—	—	54930007	—	54930007	—	—
Escutcheon plate ... ..	5	—	—	—	54330576	—	54330576	—	—
Stop Lamp ... ..	5	—	—	6SA	3448B	6SA	31827B	—	—
<b>WARNING LIGHT, MAIN BEAM</b> ... ..	4	—	—	WL15	†38189A	WL15	†38189A	WL15	†38189A
<b>REAR SUSPENSION UNIT</b> (Serviced by Girling Ltd.) ... ..	—	—	4475(SB4)	—	4475(SB4)	—	4927(SB4)	—	4545(SB4)

UNIT	See Page	440 c.c. B44 'Grand-Prix Victor'		250 c.c. C15 'Star'		D10 Bantam 'Silver', 'Supreme', 'Sports' and 'Bushman'	
		Model	Part No.	Model	Part No.	Model	Part No.
<b>ALTERNATOR serviced by:—</b>	3	RM19	—	RM18	—	—	—
Rotor ... ..	3	—	54213901	—	54213903	—	—
Stator ... ..	3	—	47197A	—	47161B	—	—
<b>AMMETER</b> ... ..	3	—	—	CZU27	36084F	—	—
<b>BATTERY</b> ... ..	—	—	—	MLZ9E	54028459	PUZ5E-11	24082094
<b>CABLE HARNESS</b> ... ..	—	—	54938164	—	54937919	—	—
Export U.S.A. ... ..	—	—	—	—	54937920	—	—
<b>COIL, IGNITION</b> ... ..	3	3ET	45149A	MA6	45152B	—	—
<b>CONTACT BREAKER</b> ... ..	3	4CA	*47624A (54415296 and 54417989)	4CA	*47621D (54415296 and 54416405)	—	—
<b>HORN</b> ... ..	—	—	—	6H	*70196A (70182)	—	—
<b>LAMPS</b>							
Head							
Home and Export ... ..	4	—	—	MCF575P	58234D	—	—
Export Europe ... ..	4	—	—	MCF575P	58392A	—	—
Export France ... ..	4	—	—	MCF575P	58391A	—	—
Stop tail, number plate illumination and reflex	5	—	—	564	53432D	—	—
Export U.S.A. ... ..	5	—	—	679	53972D	679	53972D
<b>RECTIFIER</b> ... ..	3	—	—	2D5506	49072A	—	—
<b>SWITCHES</b>							
Ignition ... ..	5	—	—	88SA	34427B	—	—
Cover ... ..	5	—	—	—	54336178	—	—
Escutcheon plate ... ..	5	—	—	—	54330576	—	—
Lighting ... ..	5	—	—	88SA	34289A	—	—
Knob ... ..	5	—	—	—	†54330934	—	—
Escutcheon plate ... ..	5	—	—	—	54330576	—	—
Stop lamp ... ..	5	—	—	6SA	34427B	—	—
<b>REAR SUSPENSION UNIT</b> (Serviced by Girling Ltd.) ... ..	—	—	4757(SB4)	—	3972(SC2-6)	—	3983 (SC3) 4911 (SC3)

When ordering, quote part number shown in brackets. † Part of headlamp. ‡ 2 off. (D10 Bantam 'Silver' and 'Supreme' only. †† 'Sports' and 'Bushman' only.





**ALTERNATOR STATORS**

Part No. ... ..	47161B	47162A	47197A
Model ... ..	RM18	RM19	RM19
Cable clip ... ..	54213907	54210167	—
Washer, cable clip ... ..	131023	131023	—

**RECTIFIER**

Part No. ... ..	49072A
Model ... ..	2DS506
Nut, fixing ... ..	156594

**AMMETERS**

Part No. ... ..	36084F	36296A
Model ... ..	CZU27	2AR
Ring, rubber ... ..	523986	—
Nut, terminal ... ..	166043	166043
Washer, terminal ... ..	185040	185040

**CONTACT BREAKER UNITS**

Part No. ... ..	47612E	47612D
Model ... ..	4CA	4CA
Contact breaker ... ..	425379	54415296
Contact set ... ..	54415803	54415803
Nut, condenser angle plate fixing ... ..	169194	169194
Plate, condenser terminal insulating ... ..	425382	425382
Condenser ... ..	425377	425377
Plate, contact breaker base ... ..	425370	425370
Felt, cam lubricating ... ..	425378	425378
Auto advance unit ... ..	54416150	54416405
Cam ... ..	54415053	54440029
Springs, auto advance ... ..	54415641	54415640
Weights, auto advance ... ..	54440031	54440031
Sleeve and action plate ... ..	54415749	54415749

Part No. ... ..	47624A	47628A
Model ... ..	4CA	4CA
Contact breaker ... ..	54415296	425379
Contact set ... ..	54415803	54415803
Nut, condenser angle plate fixing ... ..	169194	169194
Plate, condenser terminal insulating ... ..	425382	425382
Condenser ... ..	425377	425377
Plate, contact breaker base ... ..	425370	425370
Felt, cam lubricating ... ..	425378	425378
Auto advance unit ... ..	54417989	54419167
Cam ... ..	54415053	—
Springs, auto advance ... ..	54417992	54113020
Weights, auto advance ... ..	54440031	—
Sleeve and action plate ... ..	54417203	—

**HORNS**

Part No. ... ..	70196A	70197A
Model ... ..	6H	6H

**IGNITION COILS**

Part No. ... ..	45152B	45110D	45149A
Model ... ..	MA6	MA12	45150A 3ET
Grommet, rubber ... ..	421554	421554	—
Clip, cable contact ... ..	421863	421863	—
Nut, terminal ... ..	166043	166043	—
Clip, coil retaining ... ..	—	—	54441104
Lamination ... ..	—	—	54441946
Connector, double male Lucar ... ..	54190108	54190108	864980
Connector, female Lucar ... ..	—	—	54942078
Sleeve, Lucar ... ..	—	—	54190042
Washer, shakeproof terminal ... ..	188330	188330	—
Washer, plain terminal ... ..	131023	131023	—
Eyelet ... ..	—	—	187736

**FUSED EARTH LEAD**

Part No. ... ..	54938986
Eyelet ... ..	900450
Eyelet ... ..	850406
Fuse holder ... ..	54190387
Fuse 35 amp. ... ..	188218



Stator (typical)



54213901  
54213903



49345



36084



523986



36296



54441582



49072

Nut  
156594

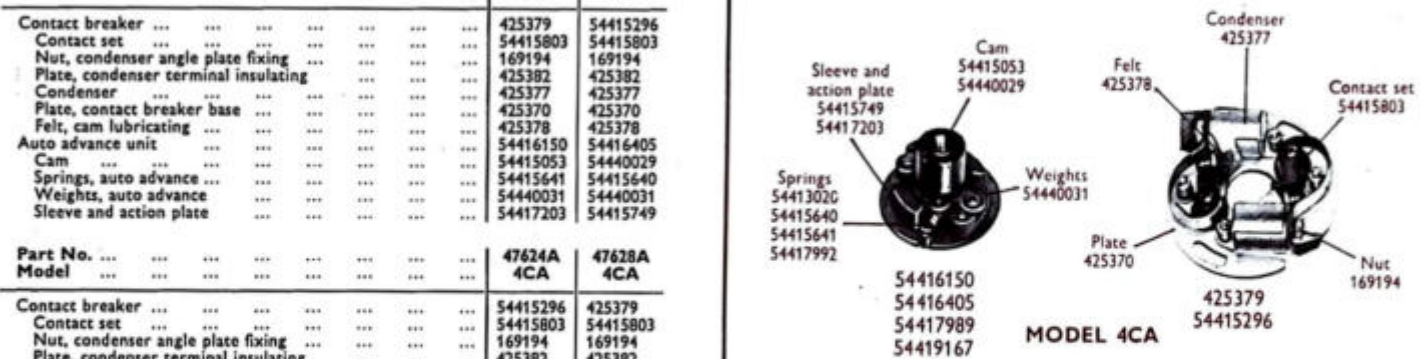

850406



900450



54190387



189218



Cable clip  
421863

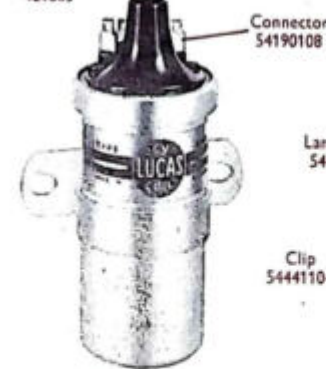

45152  
45110 (12 volt)



MODEL 6H

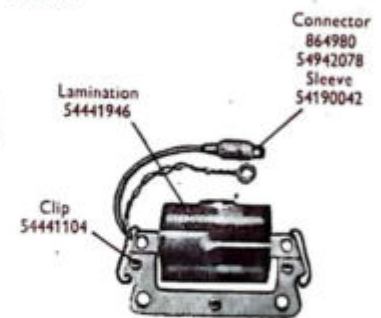

45149  
45150



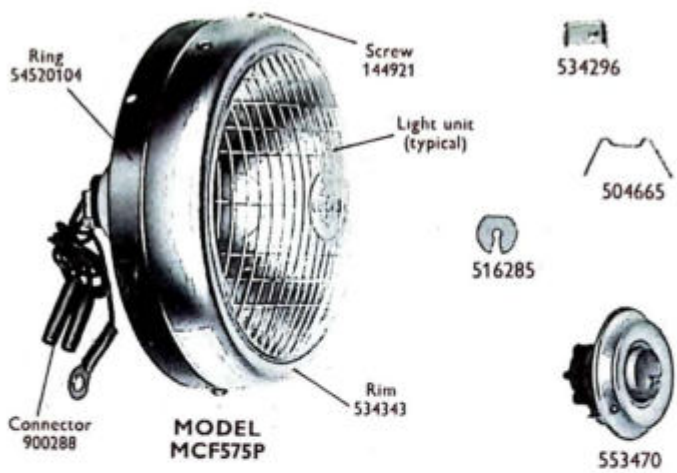

**MODEL MCF575P**

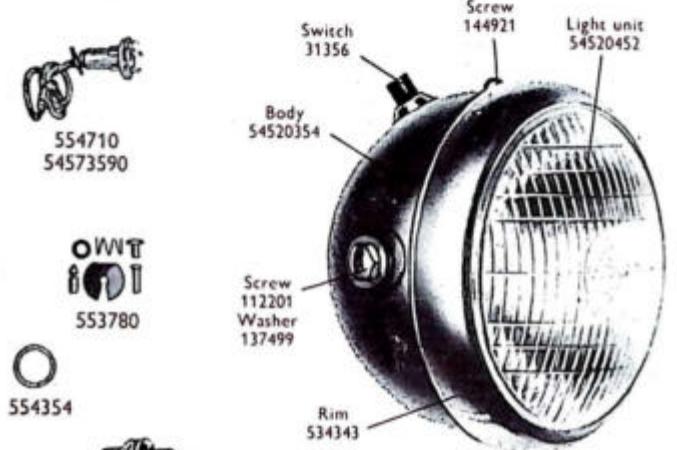

**MODEL MCH66**

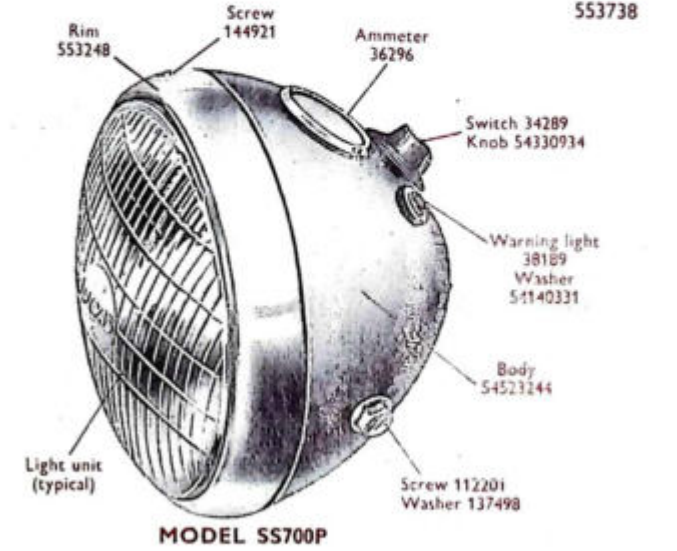

**MODEL SS700P**

**HEADLAMPS**

Part No. Model	58234D MCF575P	58391A MCF575P	58392A MCF575P
Rim	534343	534343	534343
Screw, rim fixing	144921	144921	144921
Plate, rim screw fixing	534296	534296	534296
Light unit	516828	516912	516829
Wires, light unit fixing	504665	504665	504665
Bulbholder, main	554602	553470	554602
Bulbholder	—	562303	—
Sleeve, terminal	555910	555910	555910
Bulbholder, pilot	554710	554710	554710
Interior, pilot bulbholder	553780	553780	553780
Ring, rubber	554354	554354	554354
Connector cable	900288	900288	900288
Washer cable grip	516285	516285	516285
Ring, fixing	54520104	54520104	54520104
Bulb, main	312	—	377
Bulb, pilot	988	988	988

Part No. Model	58395L MCH66
Rim or door	534343
Wire, reflector fixing	504665
Screw, rim fixing	144921
Plate, rim fixing	534296
Switch, lighting (see page 5 for details)	31356
Switch, dip (see page 5 for details)	31620
Light unit	54520452
Bulbholder, main	554602
Sleeve, terminal	555910
Grommet, cable entry	199003
Screw, lamp fixing	112201
Washer, screw fixing	137499
Warning light	38189A
Bulbholder, warning light	54945043
Bulb, warning light	282
Body	54520354
Bulb	166

Part No. Model	59658A/B SS700P	59659B/D SS700P	59660A/B SS700P
Rim or door	553248	553248	553248
Wire, fixing	504665	504665	504665
Screw, rim fixing	144921	144921	144921
Plate, rim fixing	534296	534296	534296
Ammeter (see page 3 for details)	36296	36296	36296
Warning light body assembly	38189	38189	38189
Washer, warning light sealing	54140331	54140331	54140331
Switch, lighting (see page 5 for details)	34289	34289	34289
Knob	54339034	54339034	54339034
Light unit	516798	54522680	516801
Bulbholder, main	554602	—	554602
Sleeve, terminal	555910	—	555910
Adaptor	—	553738	—
Connector, double	—	850641	—
Connector, single	—	900288	—
Sleeve, terminal	—	555910	—
Bulbholder, pilot	554710	54579590	554710
Interior, pilot	553780	553780	553780
Ring, rubber, seating	554354	554354	554354
Washer, cable grip pilot	516285	516285	516285
Screw, lamp fixing	112201	112201	112201
Washer, lamp screw fixing	137498	137498	137498
Body	54523244	54523244	54523244
Bulb, main	446	411	370
Bulb, pilot	989	989	989



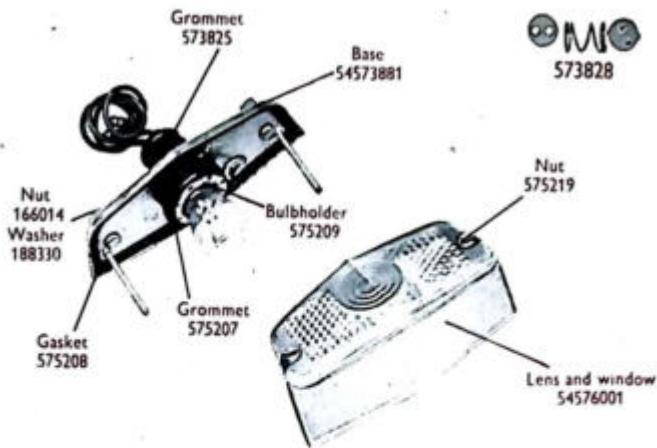

**MODEL 564**

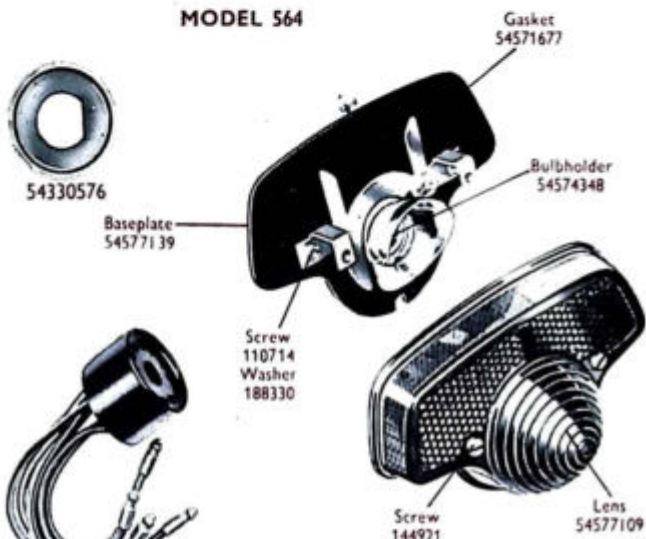

**MODEL 679**

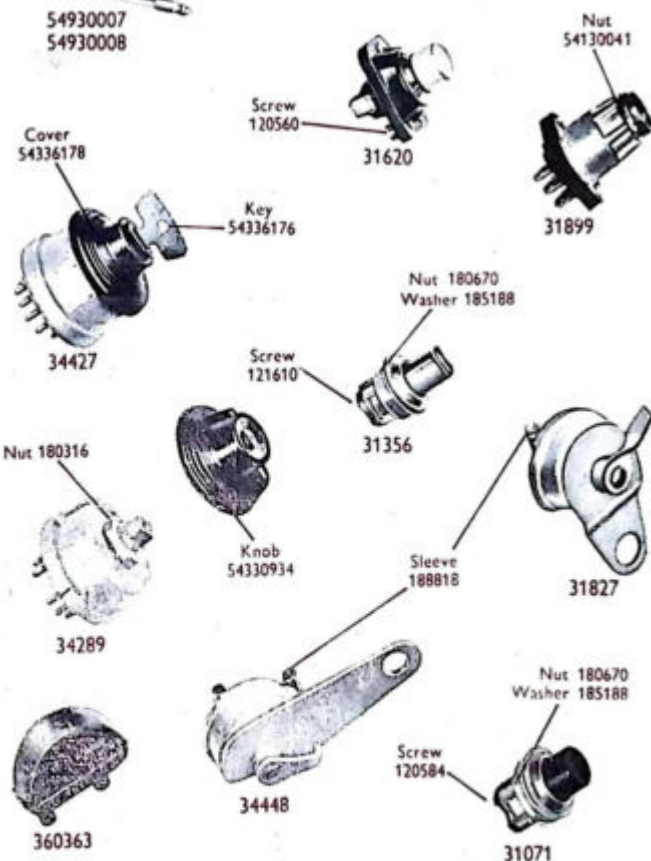

**STOP TAIL, REFLEX AND NUMBER  
PLATE ILLUMINATION LAMPS**

Part No.	Model	53394D	564
Lens and window	...	...	54576001
Nut, lens fixing	...	...	575219
Gasket, lens seating	...	...	575208
Base	...	...	54573881
Grommet, bulbholder	...	...	575207
Bulbholder, shell	...	...	575209
Interior, bulbholder	...	...	573828
Grommet cable	...	...	573825
Nut, lamp fixing	...	...	166014
Washer, shakeproof	...	...	188330
Washer, spacer, bolt fixing	...	...	131023
Bulb	...	...	352

Part No.	Model	53972D	53973D
		679	679
Lens	...	54577109	54577109
Screw, lens fixing	...	144921	144921
Bulbholder, with reflector	...	54574348	54574348
Interior, bulbholder	...	573828	573828
Baseplate	...	54577139	54577139
Gasket, lamp seating	...	54571677	54571677
Screw, lamp fixing	...	110714	110714
Washer, screw fixing	...	—	188330
Bulb	...	384	380

**DIPPER SWITCH**

Part No.	Model	31620F	PS9
Screw, terminal	...	...	120560

**IGNITION SWITCHES**

Part No.	Model	31899B	3427B
		545	885A
Key	...	—	54336176
Socket with cables	...	—	*54930008
Nut, fixing	...	54130041	54336177
Cover	...	—	*54336178

**LIGHTING SWITCHES**

Part No.	Model	31356B	34289A
		PS6	885A
Screw, terminal	...	121610	—
Socket with cables	...	—	*54930007
Washer, spring, nut fixing	...	185188	—
Nut, fixing	...	180670	180316
Knob	...	—	*54330934

**STOP LAMP SWITCHES**

Part No.	Model	31827B	3448B
		65A	65A
Sleeve, terminal	...	188818	188818
Cover, rubber, terminal	...	—	360363

**CUT-OUT SWITCH**

Part No.	Model	31071D
		SS5
Screw, terminal	...	120584
Nut, fixing	...	180670
Washer, spring	...	185188

\* Order separately



**BULBS**

Part No.	Volts	Watts	Description
166	6	24/24	Transverse, vertical dip
281	12	2	Miniature bayonet cap
282	6	0-6	Miniature bayonet cap
312	6	30/24	Transverse, vertical dip
352	6	18/3	Transverse, offset pin
370	12	40/50	Transverse and Hooded axial Duplo-Vertical dip
377	6	25/25	Transverse, vertical dip
380	12	21/6	Transverse, offset pin
384	6	18/6	Transverse, offset pin
411	12	45/40	Duplo filament, yellow
446	12	50/40	Transverse, vertical dip
988	6	3	Coil, miniature bayonet cap
989	12	6	Coil, miniature bayonet cap

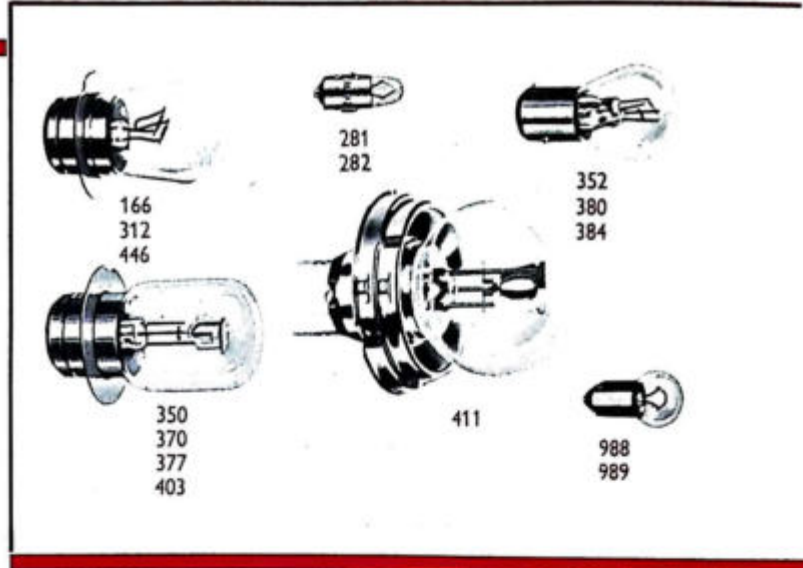

**CABLE HARNESSES**

Part No.	...	...	...	...	...	...	...	54933943	54934952	54937919 54937920	54938164	54950625	54952732
Eyelet ( $\frac{3}{8}$ "	...	...	...	...	...	...	...	—	—	850405	—	850405	—
Eyelet, short ( $\frac{3}{8}$ "	...	...	...	...	...	...	...	—	—	187009	—	—	187009
Eyelet ( $\frac{1}{2}$ "	...	...	...	...	...	...	...	850406	—	850406	850406	850406	850406
Eyelet ( $\frac{5}{8}$ "	...	...	...	...	...	...	...	—	—	—	—	900450	900450
Connector, Lucar (17.5 amp.)	...	...	...	...	...	...	...	54942078	—	54942078	54942078	54942078	54942078
Connector, Lucar (35 amp.)	...	...	...	...	...	...	...	—	—	—	—	54942079	54942079
Connector, Lucar (17.5 amp. double)	...	...	...	...	...	...	...	—	54942747	54942747	—	54190030	54942747
Sleeve, Lucar (17.5 amp.)	...	...	...	...	...	...	...	54190042	—	54190042	54190042	54190042	54190042
Sleeve, Lucar (35 amp.)	...	...	...	...	...	...	...	—	—	—	—	54190043	54190043
Sleeve, Lucar (17.5 amp. double)	...	...	...	...	...	...	...	—	54190119	54190119	—	54190119	54190119
Lucar blade	...	...	...	...	...	...	...	864980	—	—	—	—	—
Connector tube (2-way)	...	...	...	...	...	...	...	900288	900288	900288	900288	900288	900288
Connector tube (4-way)	...	...	...	...	...	...	...	850641	—	850641	850641	850641	850641
Connector tube (6-way)	...	...	...	...	...	...	...	850844	—	—	850844	—	—
Nipple	...	...	...	...	...	...	...	900269	900269	900269	900269	900269	900269
Fuseholder, in line	...	...	...	...	...	...	...	—	—	—	—	—	54190387
Fuse	...	...	...	...	...	...	...	—	—	—	—	—	188218
Bulbholder	...	...	...	...	...	...	...	—	—	54941458	—	54945043	54945043
Bulb	...	...	...	...	...	...	...	—	—	282	—	281	281

**JOSEPH LUCAS (Sales & Service) LIMITED · BIRMINGHAM 18 · ENGLAND**

Compiled and issued by Parts Publications, Technical Records Department, Joseph Lucas (Sales and Service) Ltd., Great Hampton Street, Birmingham 18

© Joseph Lucas (Sales and Service) Ltd.

Printed in England